

2130	1680	350

67ГЛ / 2963

Комплектовочная ведомость / Set package sheet

Упак/ Package	Наименование	Description	Цвет детали/ Décor	Размер / Size, mm	Кол-во/ Quantity	№
1	Фурнитура	Furniture/Cabinetry hardware	-	-	-	-
	Боковина (под петли)	Side (hinge)	White	920x334	2	5
	Крыша	Top	White	400x334	4	7
	Боковина	Side	White	920x334	2	6
2	Крыша	Top	White	1730x334	1	8
	Боковина левая ср	Side left middle	White	320x330	1	2
	Боковина правая ср	Side right middle	White	320x330	1	3
	Вязка	Connecting element	White	366x334	1	10
	Вязка	Connecting element	White	649x330	1	11
	Боковина левая	Side left	White	320x330	1	1
	Боковина правая	Side right	White	320x330	1	4
	Вязка	Connecting element	White	366x334	1	10
	Вязка	Connecting element	White	649x330	1	11
	Крыша	Top	White	1730x330	1	9
3	Вязка	Connecting element	White	1730x200	1	12
	Задник	Back element	White	1730x200	1	13
4	ДВП	Back element	White	948x396	1	14
	Створка	Door	White gl	958x396	1	17
	Створка	Door	White gl	358x396	1	18
	ДВП	Back element	White	335x389	1	15
	Створка	Door	White gl	958x396	1	17
	ДВП	Back element	White	948x396	1	14
5	Створка	Door	White gl	1326x224	1	19
	ДВП	Back element	White	1334x214	1	16

(PL) Instrukcja montażu

(CZ) Návod k montáži

(D) Montageanleitung

(GB) Assembly instruction

(F) Model d'emploi

(HU) Szerelési útmutató

(I) Istruzione di montaggio

(NL) Handleiding voor de montage



(RU) Инструкция по монтажу

(RO) Instrucțiuni de montare

(SK) Návod k montáži

(TR) Montaj talimatı

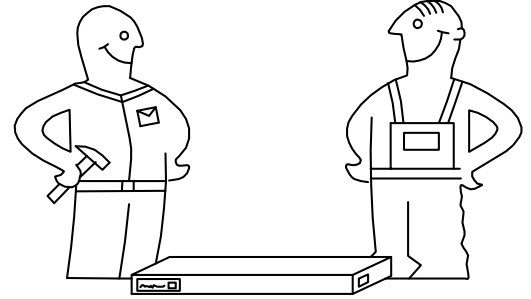
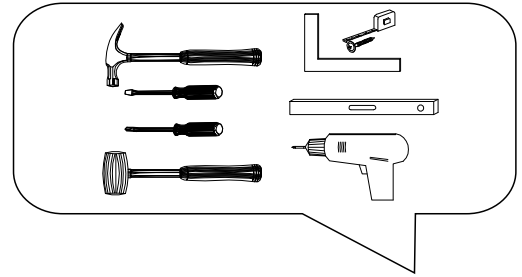



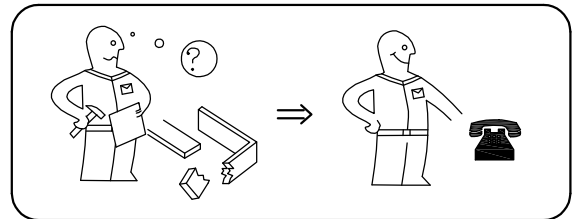
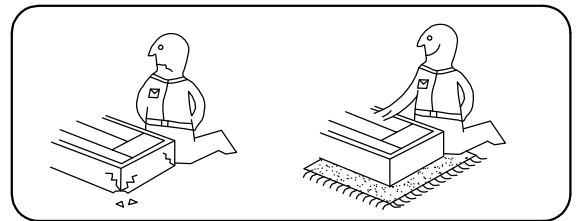



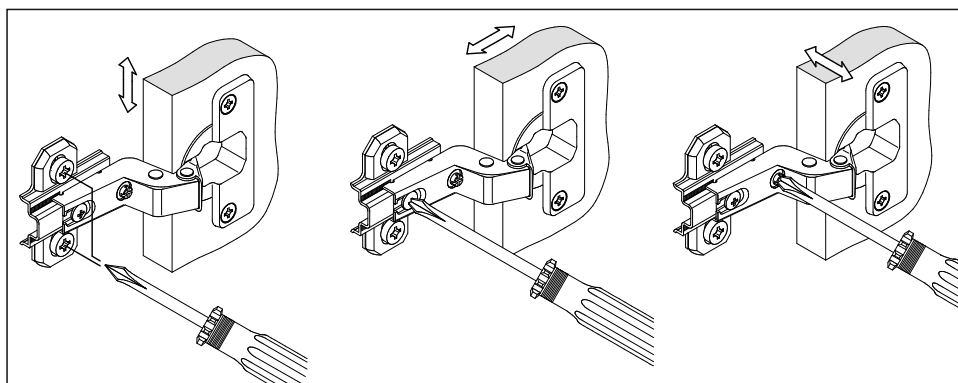
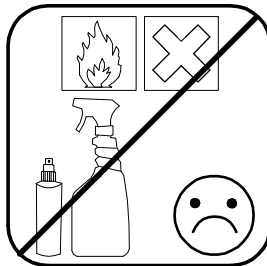
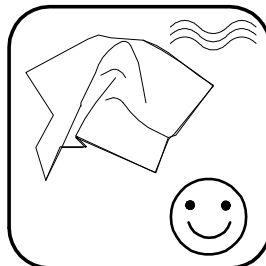
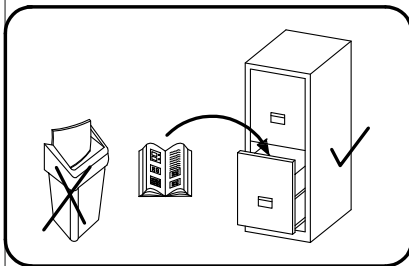

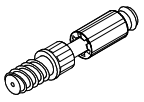

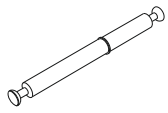
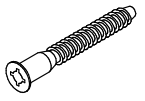
⚠ Uwaga • Upozornění • Achtung • Attention • Caution • Figyelem ⚠ Attenzione • Opgelet • Внимание • Atenție • Upozornenie • Dikkat	
PL	Czyszczenie należy wykonać wyłącznie za pomocą ściereczki lub lekko nawilżonego ręcznika. Nie stosować środków czyszczących do szorowania.
CZ	Čistění je nutné vykonávat výhradně pomocí utěrky nebo lehce navlhčeného ručníku. Nepoužívejte čističe obsahující abrazivní částice.
D	Bitte nur mit einem Staubtuch oder leicht feuchtem Lappen reinigen. Keine scheuernden Putzmittel verwenden.
GB	Please only clean with a duster or a damp cloth. Do not use any abrasive cleaners.
F	Le nettoyage se fait uniquement à l'aide d'un torchon ou d'une serviette légèrement mouillée.
HU	A tisztítás kizárólag törülköh vagy enyhén nedvesített törölköző segítségével végezhető. Súroló hatású tisztítószerket nem szabad használni.
I	Pulire esclusivamente con un panno o un asciugamano umido.
NL	Reinig alleen met een stofdoek of een lichtjes vochtige doek. Gebruik geen schurende poetsmiddelen.
RU	Очищайте от пыли тряпкой или слегка влажной ветошью. Не допускается применение чистящих средств, не предназначенных для ухода за мебелью.
RO	Curățarea trebuie efectuată numai cu o cârpă sau cu un prosop ușor umezit. Nu utilizați agenți de curățare abrazivi.
SK	Čistení je nutné vykonávať výhradne pomocí utierky alebo ľahko zvlhnutým ručníkom. Nepoužívajte čistiace prostriedky obsahujúce abrazívne častice.
TR	Lütfen sadece bir toz bezilye veya hafif nemli yumuşak bir bezle siliniz. Aşındırıcı temizlik malzemeleri kullanmayınız.

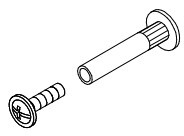
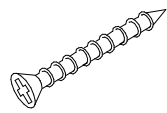

**Karta serwisowa • Servisní list • Service Karte • Service card • Carte de service • Szervizkártya
Scheda di servizio • Service kaart • Сервисная карта • Fisa service • Servisný list • Servis karti**

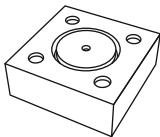
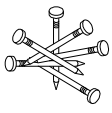

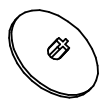
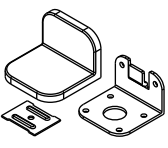
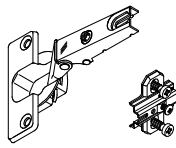
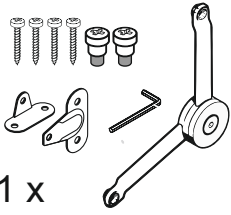
1		2		3		4		5	7x50
									
36 x		40 x		4 x		2 x		13 x	
6	6,3x10,5	9		10	3,5x25	15		18	3,5x15
									
18 x		2 x		8 x		1 x		85 x	
31	SAH302	38		48	2x20	53		73	
									
2 x		12 x		70 x		2 x		40 x	
69		91	Hinge A	97					
									
1 x		9 x		1 x					

